



Linebacker® Series Cable Protectors

- Checkers' most robust cable protection option
- High load bearing capacity for heavy duty equipment
- Ideal for oil, gas, mining, military, construction, or any heavy-duty application



Checkers' Most Robust Line of Cable Protectors

Linebacker Cable Protectors provide a safer crossing for vehicles and pedestrian traffic while protecting valuable electrical cables and hose lines from damage in extreme weather conditions and work environments. The modular interlocking design can extend to any length, ideal for use in oil and gas applications, mining, military, and other industrial environments with heavy trucks and forklifts.

Choose from popular heavy-duty models, general purpose models, and models for lines up to 3.25 in outer diameter. Add ADA/DDA compliant accessories and protector bridges for unlimited channels.

- High load bearing capacity
- T-connectors won't pull apart, even under weight of heavy vehicles
- UV-stabilized, weather-resistant urethane construction
- Patented 5-bar tread surface provides maximum traction
- Reinforced hinged lid for easy cable placement
- Easy to transport, setup, disassemble and store
- Modular interlocking design to extend to any desired length
- Available in high visibility colors
- Custom logo and colors available

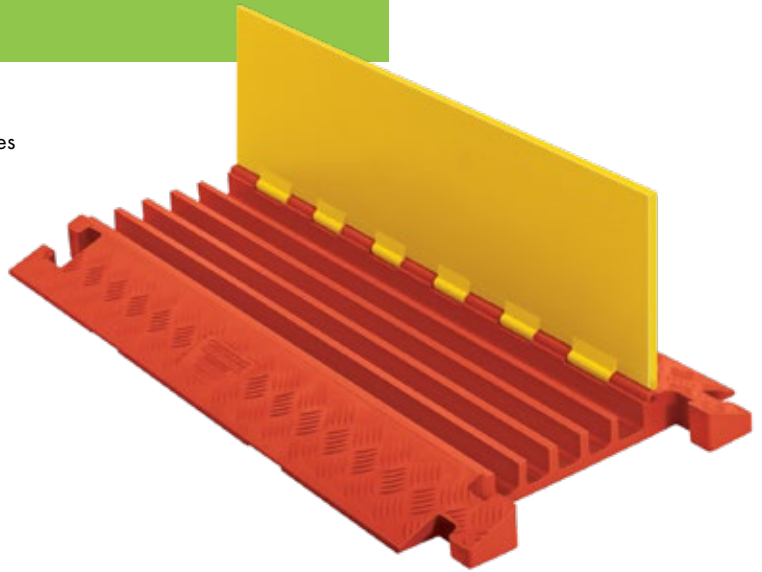

ADA compliant models are ideal for use in amusement parks, entertainment venues, sporting events, and most public, commercial, industrial, construction, and utility applications.



Models available to accommodate lines up to 3.25 in OD

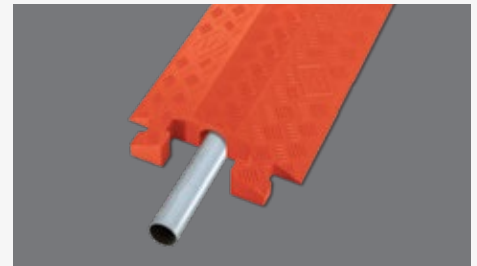

Also available in a drop over or split top style cable protector.

| Product | Model No. | Maximum OD | Load Capacity (per axle) | # of Channels | Connector type | Pg. |
|---|------------|-------------------|--------------------------|---------------|---|-----|
| Heavy Duty 5-Channel | CP5X125 | 1.35 in (3.43 cm) | 40,300 lb (18,280 kg) | 5 |  T-Shaped | 3 |
| Heavy Duty 4-Channel | CP4X125 | 1.35 in (3.43 cm) | 40,300 lb (18,280 kg) | 4 | | 3 |
| Heavy Duty 3-Channel | CP3X225 | 2.25 in (5.72 cm) | 28,420 lb (12,892 kg) | 3 | | 3 |
| Heavy Duty 2-Channel | CP2X325 | 3.25 in (8.27 cm) | 21,760 lb (9,870 kg) | 2 | | 5 |
| General Manufacturing 4-Channel | CP4X300 | 3 in (7.62 cm) | 20,200 lb (9,163 kg) | 4 | | 5 |
| General Purpose 5-Channel | CP5X125-GP | 1.3 in (3.3 cm) | 21,000 lb (9,526 kg) | 5 | | 6 |
| General Purpose Drop Over/Split Top 1.25-in H | CP1X125 | 1.25 in (3.18 cm) | 23,400 lb (10,614 kg) | 1 | | 7 |
| General Purpose Drop Over/Split Top 2.25-in H | CP1X225 | 2.25 in (5.72 cm) | 17,000 lb (7,712 kg) | 1 | | 7 |

5-Channel Heavy Duty

- Standard high-visibility yellow lid/orange base color 
- Add accessories to create turns and jogs

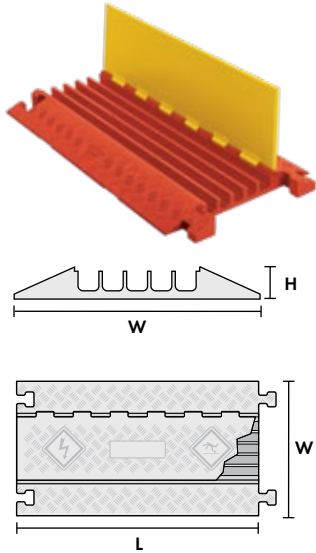

4-Channel Heavy Duty

- Standard high-visibility yellow lid/orange base color 
- Add accessories to create turns and jogs

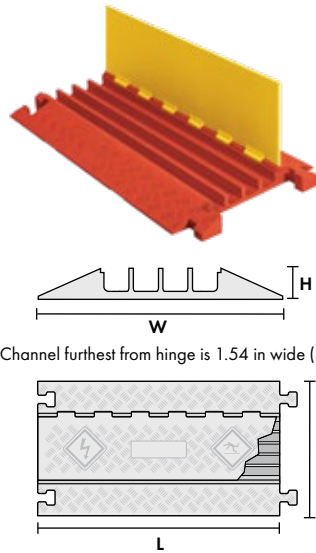

NOTE: Channel furthest from hinge is 1.54 in wide (3.92 cm)

3-Channel Heavy Duty



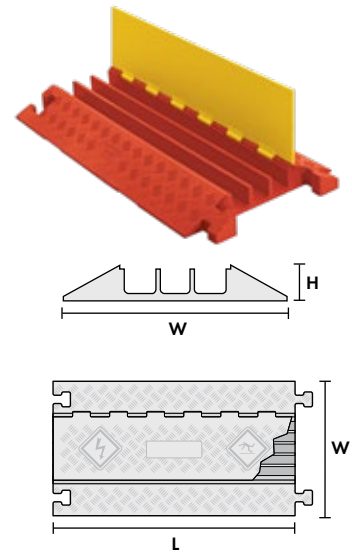









- Standard high-visibility yellow lid/orange base color 
- Add accessories to create turns and jogs



| Model | Load Capacity Max load tested at 70°F (21°C) |
|-------------------------------------|---|
| Heavy Duty 5-Channel & 4-Channel | 20,150 lb/Tire (9,140 kg) 40,300 lb/Axle (18,280 kg) |
| Heavy Duty 3-Channel | 14,210 lb/Tire (6,446 kg) 28,420 lb/Axle (12,892 kg) |

Accessories



| Model | Description | Length | Width | Height | Channel Width | Maximum OD | Weight | Prop 65 |
|----------------------------------|-------------------------|---|------------------------------------|--|--|--|------------------------------------|---|
| 5-Channel Cable Protector | | | | | | | | |
| CP5X125-Y/O | 5-CH LB HD | 36 in (91.4 cm) | 20 in (50.8 cm) | 2.31 in (5.72 cm) | 1.35 in (3.43 cm) | 1.35 in (3.43 cm) | 25 lb (11.3 kg) |  |
| CPT5X125-L-Y/O | 45° Left Turn | 25 in (63.5 cm) | 20 in (50.8 cm) | 2.31 in (5.72 cm) | 1.35 in (3.43 cm) | 1.35 in (3.43 cm) | 13 lb (5.9 kg) |  |
| CPT5X125-R-Y/O | 45° Right Turn | 25 in (63.5 cm) | 20 in (50.8 cm) | 2.31 in (5.72 cm) | 1.35 in (3.43 cm) | 1.35 in (3.43 cm) | 13 lb (5.9 kg) |  |
| CPEC5X125-O | End Caps (Pair Only) | F: 7.5 in (19 cm) M: 5.25 in (13.3 cm) | 20 in (50.8 cm) 20 in (50.8 cm) | 2.31 in (5.72 cm) 2.31 in (5.72 cm) | 1.35 in (3.43 cm) 1.35 in (3.43 cm) | 1.35 in (3.43 cm) 1.35 in (3.43 cm) | 3.5 lb (1.6 kg) 3.5 lb (1.6 kg) |  |
| 4-Channel Cable Protector | | | | | | | | |
| CP4X125-Y/O | 4-CH LB HD | 36 in (91.4 cm) | 20 in (50.8 cm) | 2.31 in (5.72 cm) | 1.85 in (4.71 cm) | 1.35 in (3.43 cm) | 26 lb (11.8 kg) |  |
| CPT4X125-L-Y/O | 45° Left Turn | 25 in (63.5 cm) | 20 in (50.8 cm) | 2.31 in (5.72 cm) | 1.85 in (4.71 cm) | 1.35 in (3.43 cm) | 13 lb (5.9 kg) |  |
| CPT4X125-R-Y/O | 45° Right Turn | 25 in (63.5 cm) | 20 in (50.8 cm) | 2.31 in (5.72 cm) | 1.85 in (4.71 cm) | 1.35 in (3.43 cm) | 13 lb (5.9 kg) |  |
| CPEC4X125-O | End Caps (Pair Only) | F: 7.5 in (19 cm) M: 5.25 in (13.3 cm) | 20 in (50.8 cm) 20 in (50.8 cm) | 2.31 in (5.72 cm) 2.31 in (5.72 cm) | 1.85 in (4.71 cm) 1.85 in (4.71 cm) | 1.35 in (3.43 cm) 1.35 in (3.43 cm) | 3.5 lb (1.6 kg) 3.5 lb (1.6 kg) |  |
| 3-Channel Cable Protector | | | | | | | | |
| CP3X225-Y/O | 3-CH LB HD | 36 in (91.4 cm) | 20 in (50.8 cm) | 3.05 in (7.75 cm) | 2.25 in (5.72 cm) | 2.25 in (5.72 cm) | 28 lb (12.7 kg) |  |
| CPT3X225-L-Y/O | 45° Left Turn | 25 in (63.5 cm) | 20 in (50.8 cm) | 3.05 in (7.75 cm) | 2.25 in (5.72 cm) | 2.25 in (5.72 cm) | 15 lb (6.8 kg) |  |
| CPT3X225-R-Y/O | 45° Right Turn | 25 in (63.5 cm) | 20 in (50.8 cm) | 3.05 in (7.75 cm) | 2.25 in (5.72 cm) | 2.25 in (5.72 cm) | 15 lb (6.8 kg) |  |
| CPEC3X225-O | End Caps (Pair Only) | F: 8.25 in (20.96 cm) M: 6 in (15.24 cm) | 20 in (50.8 cm) 20 in (50.8 cm) | 3.05 in (7.75 cm) 3.05 in (7.75 cm) | 2.25 in (5.72 cm) 2.25 in (5.72 cm) | 2.25 in (5.72 cm) 2.25 in (5.72 cm) | 4 lb (1.8 kg) 4 lb (1.8 kg) |  |

 **WARNING:** This product can expose you to chemicals including carbon black, titanium dioxide, formaldehyde, and benzyl butyl phthalate, which are known to the State of California to cause cancer and birth defects or other reproductive harm. For more information go to www.P65Warnings.ca.gov.

Accessibility Ramps and Rails

- Gradual slope and slip-resistant surface is ADA and DDA compliant
- Add ramps and rails while still having access to cables and cords; one person installation, no tools required

For 5-Channel, 4-Channel Heavy Duty

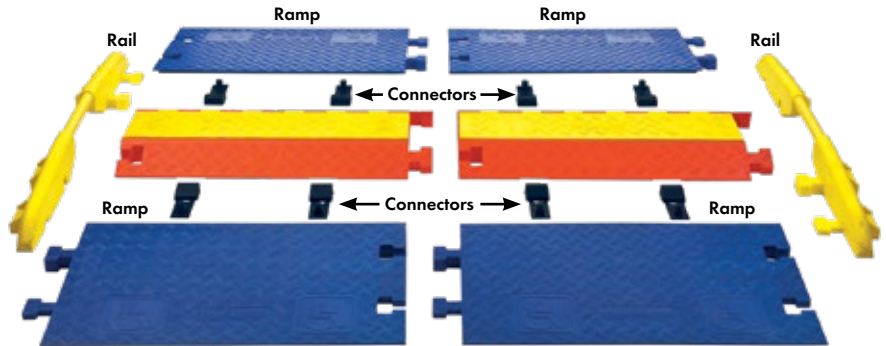
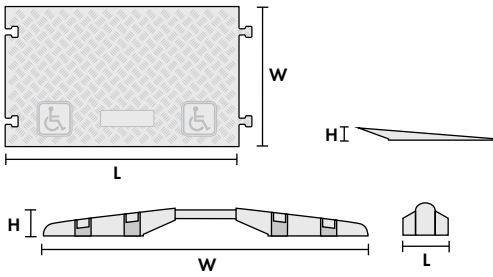

System shown with 2 Heavy Duty Linebackers, 2 Pairs of Ramps and 8 Connectors. Ramps available standard in blue and rails available only in yellow.

For 3-Channel Heavy Duty

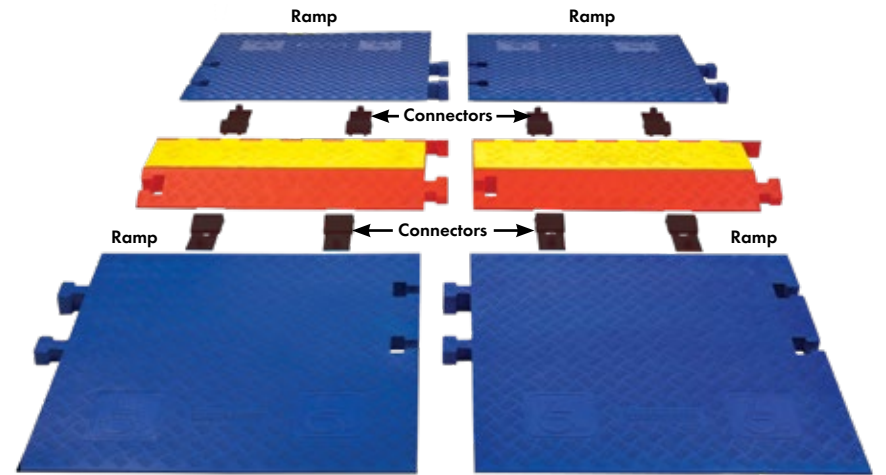
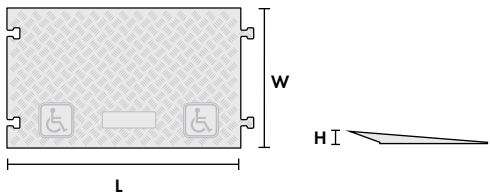

System shown with 2 Heavy Duty Linebackers, 2 Pairs of Ramps and 8 Connectors. Ramps available standard in blue.

| Model | Load Capacity Max load tested at 70°F (21 °C) |
|----------------------------------|---|
| Heavy Duty 5-Channel & 4-Channel | 20,150 lb/Tire (9,140 kg) 40,300 lb/Axle (18,280 kg) |
| Heavy Duty 3-Channel | 20,150 lb/Tire (9,140 kg) 40,300 lb/Axle (18,280 kg) |

| Model | Description | Length | Width | Height | Weight | Prop 65 |
|---|-----------------------------------|---------------------------|------------------------------|-------------------|------------------------|---------|
| 5-Channel, 4-Channel Accessibility Ramps and Rails | | | | | | |
| CPRP-4/5-BLU | ADA Ramp (2 ramps & 4 connectors) | 36 in (91.44 cm) (single) | 21.88 in (55.58 cm) (single) | 2 in (5.08 cm) | 40 lb (18.1 kg) (pair) | ⚠ |
| CPRL-4/5-Y | ADA Ramp Rail (each) | 1.5 in (3.18 cm) | 55.5 in (140.97 cm) | 2 in (5.08 cm) | 12.75 lb (5.8 kg) | ⚠ |
| 3-Channel Accessibility Ramp | | | | | | |
| CPRP-3-BLU | ADA Ramp (2 ramps & 4 connectors) | 36 in (91.44 cm) | 34.81 in (88.42 cm) | 2.88 in (7.32 cm) | 66 lb (30 kg) | ⚠ |

⚠ WARNING: This product can expose you to chemicals including carbon black, titanium dioxide, formaldehyde, and benzyl butyl phthalate, which are known to the State of California to cause cancer and birth defects or other reproductive harm. For more information go to www.P65Warnings.ca.gov.

2-Channel Heavy Duty

- Designed for cables and hoses up to 3.25 in OD
- Standard high-visibility yellow lid/orange base color 

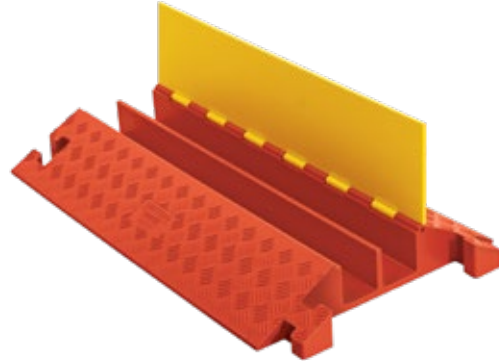
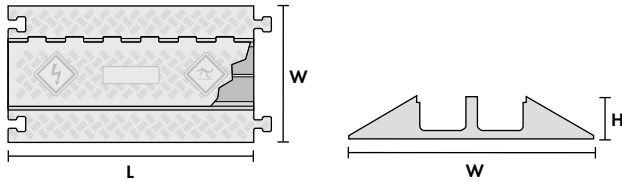

| Model | Load Capacity Max load tested at 70°F (21 °C) |
|-------------------------|--|
| Heavy Duty 2-channel | 10,880 lb/Tire (4,935 kg) 21,760 lb/Axle (9,870 kg) |

| Model | Description | Length | Width | Height | Channel Width | Maximum OD | Weight | Prop 65 |
|-------------|-------------|-----------------|------------------|--------------------|-------------------|-------------------|-----------------|---|
| CP2X325-Y/O | 2-CH HD LB | 36 in (91.4 cm) | 22 in (55.88 cm) | 4.13 in (10.16 cm) | 3.25 in (8.26 cm) | 3.25 in (8.26 cm) | 33 lb (15.0 kg) |  |

4-Channel General Manufacturing



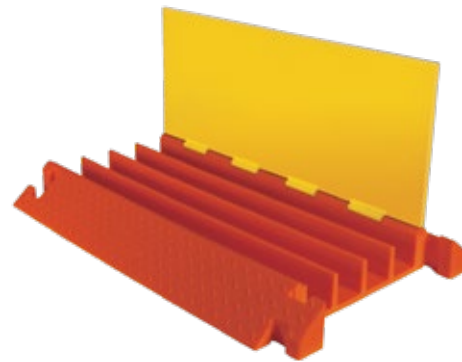
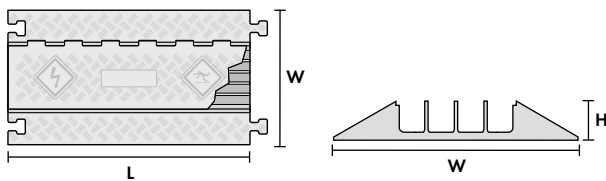

- Designed for industrial manufacturing facilities and heavy equipment areas
- Add accessories to create turns and jogs
- Standard high-visibility yellow lid/orange base color 

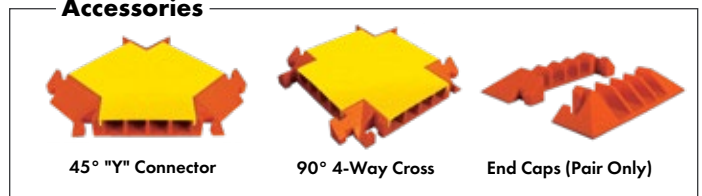

| Model | Load Capacity Max load tested at 70°F (21 °C) |
|------------------------------------|--|
| General Manufacturing 4-channel | 10,100 lb/Tire (4,581 kg) 20,200 lb/Axle (9,163 kg) |

Accessories



| Model | Description | Length | Width | Height | Channel Width | Maximum OD | Weight | Prop 65 |
|---------------|----------------------|--|--|--------------------------------------|----------------------------------|----------------------------------|-------------------------------------|---|
| CP4X300-Y/O | 4-CH Gen. Manf. LB | 36 in (91.4 cm) | 23.875 in (60.64 cm) | 3.875 in (9.84 cm) | 3 in (7.62 cm) | 3 in (7.62 cm) | 42.2 lb (19.1 kg) |  |
| CPY4X300-Y/O | 45° Y Connector | 24 in (60.96 cm) | 24 in (60.96 cm) | 3.875 in (9.84 cm) | 3 in (7.62 cm) | 3 in (7.62 cm) | 31.85 lb (14.4 kg) |  |
| CPCR4X300-Y/O | 90° 4-Way Cross | 25.5 in (64.77 cm) | 24 in (60.96 cm) | 4 in (10.16 cm) | 3 in (7.62 cm) | 3 in (7.62 cm) | 38.05 lb (17.3 kg) |  |
| CPEC4X300-O | End Caps (Pair Only) | F: 6.75 in (17.15 cm) M: 6.75 in (17.15 cm) | 23.875 in (60.64 cm) 23.875 in (60.64 cm) | 3.5 in (8.89 cm) 3.5 in (8.89 cm) | 3 in (7.62 cm) 3 in (7.62 cm) | 3 in (7.62 cm) 3 in (7.62 cm) | 6.3 lb (2.9 kg) 9.45 lb (4.3 kg) |  |

 **WARNING:** This product can expose you to chemicals including carbon black, titanium dioxide, formaldehyde, and benzyl butyl phthalate, which are known to the State of California to cause cancer and birth defects or other reproductive harm. For more information go to www.P65Warnings.ca.gov.

5-Channel General Purpose

- Standard high-visibility yellow lid/orange base color 
- Add accessories to create turns and jogs

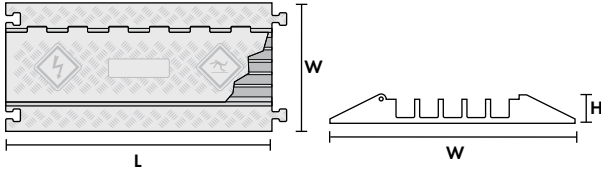

| Model | Load Capacity Max load tested at 70°F (21°C) |
|------------------------------|--|
| General Purpose 5 channel | 10,500 lb/Tire (4,763 kg) 21,000 lb/Axle (9,526 kg) |

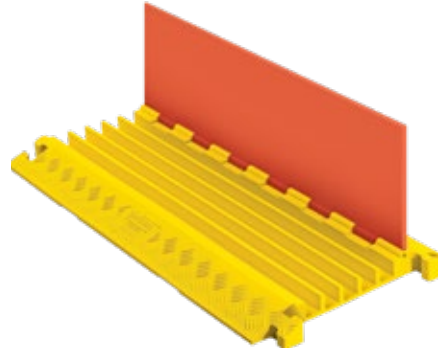



Accessories



45° "Y" Connector



End Caps (Pair Only)

| Model | Description | Length | Width | Height | Channel Width | Maximum OD | Weight | Prop 65 |
|-----------------|-------------------------|--|---------------------|------------------|-----------------|-----------------|-----------------|---|
| CP5X125-GP-O/Y | 5-CH GP LB | 36 in (91.44 cm) | 17.25 in (43.82 cm) | 1.95 in (5.0 cm) | 1.3 in (3.3 cm) | 1.3 in (3.3 cm) | 22 lb (10 kg) |  |
| CPY5X125-GP-O/Y | 45° Y Conn. | 17.25 in (43.82 cm) | 17.25 in (43.82 cm) | 1.95 in (5.0 cm) | 1.3 in (3.3 cm) | 1.3 in (3.3 cm) | 9.4 lb (4.3 kg) |  |
| CPEC5X125-GP-O | End Caps (Pair Only) | F: 4.75 in (12.07 cm) M: 4.75 in (12.07 cm) | 17.25 in (43.82 cm) | 1.95 in (5.0 cm) | 1.3 in (3.3 cm) | 1.3 in (3.3 cm) | 2.7 lb (1.2 kg) |  |

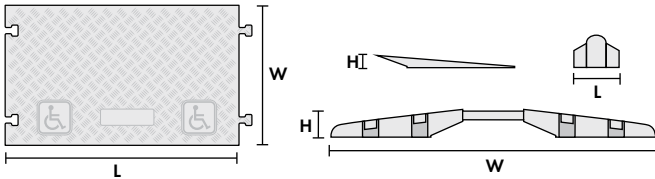

Accessibility Ramps and Rails

- Gradual slope and slip-resistant surface is ADA and DDA compliant
- Add ramps and rails while still having access to cables and cords; one person installation, no tools required

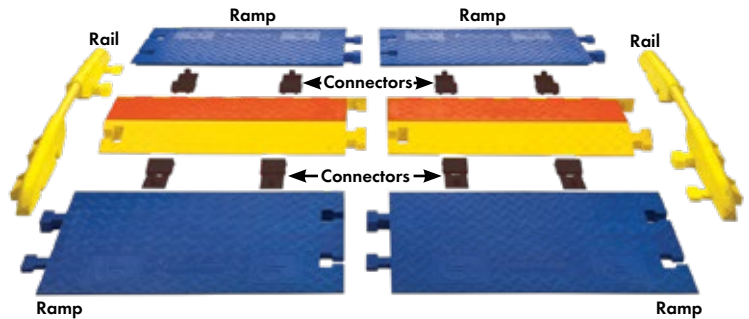

| Model | Load Capacity Max load tested at 70°F (21°C) |
|--|---|
| Accessibility Ramps & Rails, Protector Bridge | 20,150 lb/Tire (9,140 kg) 40,300 lb/Axle (18,280 kg) |



| Model | Description | Length | Width | Height | Weight | Prop 65 |
|--------------|-----------------------------------|---------------------------|------------------------------|----------------|------------------------|---|
| CPRP-5GP-BLU | ADA Ramp (2 ramps & 4 connectors) | 36 in (91.44 cm) (single) | 21.88 in (55.58 cm) (single) | 2 in (5.08 cm) | 40 lb (18.1 kg) (pair) |  |
| CPRL-5GP-Y | ADA Ramp Rail (each) | 1.5 in (3.81 cm) | 54 in (137.16 cm) | 2 in (5.08 cm) | 12.7 lb (5.8 kg) |  |

Protector Bridge

- 2-channel bridge adds cable channels while creating a continuous, level, crossing surface for vehicle and pedestrian traffic
- Expand to an unlimited number of channels

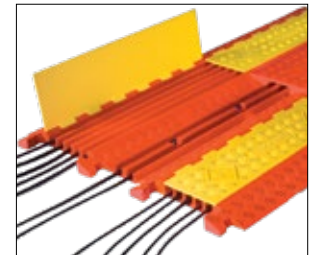
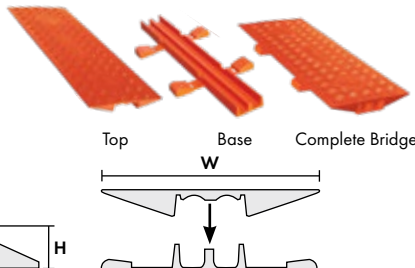

| Model | Description | Length | Width | Height | Channel Width | Maximum OD | Weight | Prop 65 |
|---------------|-----------------------|------------------|-------------------|--------------------|------------------|------------------|----------------|---|
| CL2X150-5GP-O | 2-CH Protector Bridge | 36 in (91.44 cm) | 12.5 in (21.6 cm) | 1.875 in (4.76 cm) | 1.5 in (3.81 cm) | 1.5 in (3.81 cm) | 14 lb (6.4 kg) |  |

 **WARNING:** This product can expose you to chemicals including carbon black, titanium dioxide, formaldehyde, and benzyl butyl phthalate, which are known to the State of California to cause cancer and birth defects or other reproductive harm. For more information go to www.P65Warnings.ca.gov.

1-Channel General Purpose

- Drop Over or Split Top models available
- Available in 3 color options (specify color after model number)
 - O (orange)
 - B (black)
 - Y (yellow)



| Model | Load Capacity Max load tested at 70°F (21 °C) |
|--------------------|---|
| 1-channel, 1.25 in | 11,700 lb/Tire (5,307 kg) 23,400 lb/Axle (10,614 kg) |
| 1-channel, 2.25 in | 8,500 lb/Tire (3,856 kg) 17,000 lb/Axle (7,712 kg) |

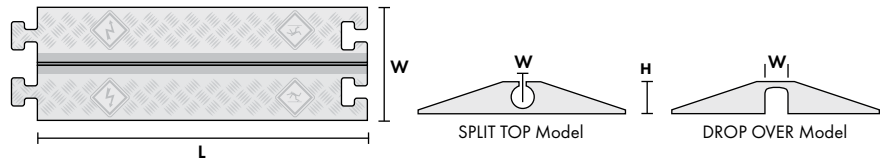

| Model | Description | Length | Width | Height | Maximum OD | Weight | Prop 65 |
|----------------|------------------------------|------------------|---------------------|------------------|-------------------|-----------------|---------|
| CP1X125-GP* | 1.25 in 1-CH GP Split Top CP | 36 in (91.44 cm) | 11.5 in (29.21 cm) | 1.6 in (4.06 cm) | 1.25 in (3.18 cm) | 13 lb (5.9 kg) | ⚠ |
| CP1X125-GP-DO* | 1.25 in 1-CH GP Drop Over CP | 36 in (91.44 cm) | 11.5 in (29.21 cm) | 1.6 in (4.06 cm) | 1.25 in (3.18 cm) | 13 lb (5.9 kg) | ⚠ |
| CP1X225-GP* | 2.25 in 1-CH GP Split Top CP | 36 in (91.44 cm) | 14.25 in (36.19 cm) | 3 in (7.62 cm) | 2.25 in (5.72 cm) | 24 lb (10.9 kg) | ⚠ |
| CP1X225-GP-DO* | 2.25 in 1-CH GP Drop Over CP | 36 in (91.44 cm) | 14.25 in (36.19 cm) | 3 in (7.62 cm) | 2.25 in (5.72 cm) | 24 lb (10.9 kg) | ⚠ |

*Specify color option after model number

Accessibility Ramps and Rails

- Gradual slope and slip-resistant surface is ADA and DDA compliant
- Add ramps and rails while still having access to cables and cords; one person installation, no tools required

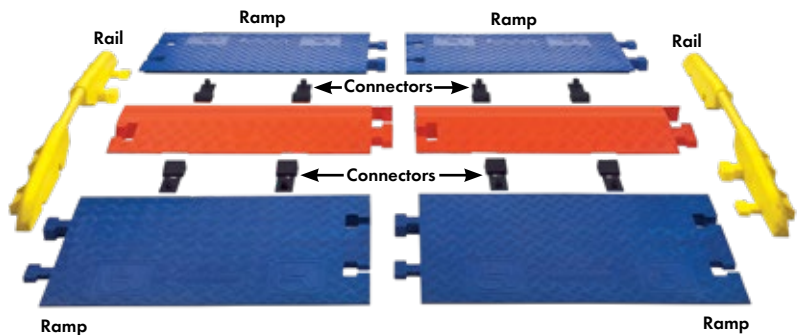
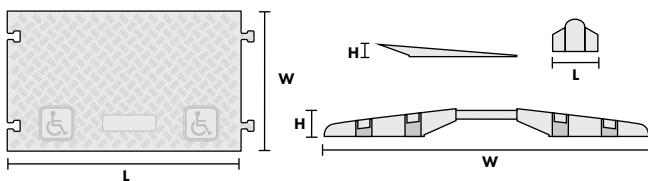

| Load Capacity Max load tested at 70°F (21 °C) |
|---|
| 20,150 lb/Tire (9,140 kg) 40,300 lb/Axle (18,280 kg) |

| Model | Description | Length | Width | Height | Weight | Prop 65 |
|----------------|---|---------------------------|------------------------------|-------------------|------------------------|---------|
| CPRP-1X125-BLU | ADA Ramp (2 ramps & 4 connectors) for 1 Channel, 1.25 in OD | 36 in (91.44 cm) (single) | 21.88 in (55.58 cm) (single) | 2 in (5.08 cm) | 40 lb (18.1 kg) (pair) | ⚠ |
| CPRL-1X125-Y | ADA Ramp Rail (each) | 1.5 in (3.81 cm) | 47 in (119.38 cm) | 2 in (5.08 cm) | 12.7 lb (5.8 kg) | ⚠ |
| CPRP-1X225-BLU | ADA Ramp (2 ramps & 4 connectors) for 1 Channel, 2.25 in OD | 36 in (91.44 cm) (single) | 34.81 in (88.42 cm) (single) | 2.88 in (7.32 cm) | 66 lb (30 kg) (pair) | ⚠ |

⚠ WARNING: This product can expose you to chemicals including carbon black, titanium dioxide, formaldehyde, and benzyl butyl phthalate, which are known to the State of California to cause cancer and birth defects or other reproductive harm. For more information go to www.P65Warnings.ca.gov.

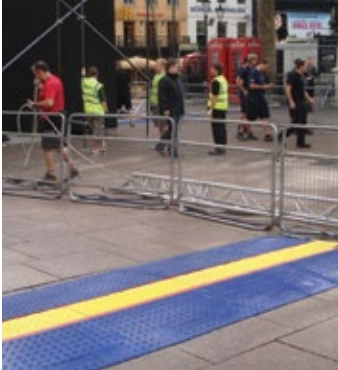

Checkers

620 Compton St
Broomfield, CO 80020

Phone: (800) 438-9336

Fax: (720) 890-4858

Email: sales@checkers-safety.com

Checkers-Safety.com